

APLIQUÉ A MURO WAQAR 1*GU10

FS
FOLUX SPA

ventas@foluxspa.cl
Cel: +5940882010

Información Técnica

SKU	° Kelvin	Potencia	Lúmenes	Eficiencia	Ángulo	CRI	Vida Útil	Voltaje
17001	N/A	Máx 15W	N/A	N/A	N/A	N/A	N/A	175-265V



**IP
20**

**1
AÑOS
GARANTÍA**

Dimensiones MM

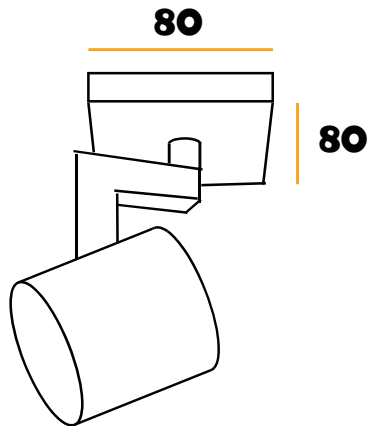

WWW.FOLUXSPA.CL